



ROHDE & SCHWARZ

Make ideas real



IoT DESIGN GUIDE

Antenna design, measurement and optimization

Contents

1. The antenna makes the difference	3
2. Antenna selection based on data sheets	4
2.1 Antenna principles	4
2.2 Antenna matching.....	5
2.3 Antenna efficiency	6
2.4 Antenna polarization and radiation.....	7
2.5 Antenna gain	9
3. Factors affecting embedded antenna performance	10
3.1 Ground plane dimensions.....	10
3.2 Other nearby components.....	12
3.3 Enclosure proximity and material effects	13
3.4 Position within the device	13
3.5 Layout of the PCB.....	15
4. Next generation multi-band antennas	16
5. Validating and optimizing antenna performance	18
5.1 Basic antenna measurements with a vector network analyzer	19
5.2 Over-the-air measurements	20
6. Summary	21
7. Learn more	21
8. Rohde & Schwarz products for IoT antenna testing	22

1. THE ANTENNA MAKES THE DIFFERENCE

THIS IoT DESIGN GUIDE IS INTENDED TO HELP IoT DEVICE DESIGN ENGINEERS SELECT, INTEGRATE AND OPTIMIZE THE MOST SUITABLE ANTENNA TO ACHIEVE THE DESIRED RADIO PERFORMANCE

Internet of things (IoT) applications often count on reliable connectivity to access sensor data or to control devices and machines. The performance of wireless interfaces is therefore crucial for the success of IoT applications that use wireless networking.

For example, smart meter applications often connect several thousand water meters installed in basements, which frequently have limited network coverage. Best-in-class RF performance is therefore essential to ensure that all meters have continuous network access.

In addition to coverage and range, data rates, latency and power consumption also depend on the radio performance and the ability to efficiently receive and transmit radio waves. Under difficult RF conditions, messages could be lost and need to be sent again by higher layers or the modem has to apply coverage enhancement techniques such as those known from NB-IoT or LTE-M. Both will extend the on-air time of the devices, thereby helping reduce the battery life. The implications in terms of latency and reaction times are obvious.

In a test laboratory, it is possible to simulate an ideal radio environment that is free from obstacles, reflection, distortion and interference, enabling perfect line of sight (LOS) radio links to be established. But in reality, this is quite different. Wireless devices have to deal with a real-world radio environment. Some IoT applications may encounter even greater difficulties.



Connecting cows wherever they go grazing

For example, the integration of wireless communication in wearables and smart glasses, lenses and rings faces several challenges due to design and application constraints.

Ensuring reliable connectivity in harsh radio environments such as mines, steelworks and harbors requires robust antenna designs.

Moreover, in a world of ubiquitous wireless connectivity, multiple wireless technologies are competing in a limited frequency spectrum and often operating together in license exempt frequency bands such as the 2.4 GHz band.

As a result, it is necessary to consider how to address increasing noise and interference in challenging multipath environments such as factory floors.

Antennas are constrained by the form factor, housing and electronic design. To optimize RF performance, designs should minimize interference between antennas while maximizing efficiency and bandwidth.

2. ANTENNA SELECTION BASED ON DATA SHEETS

EFFICIENCY, DIMENSIONS AND COST ASPECTS MATTER

The process of selecting the right antenna for your application can be challenging. Successful integration of antennas, particularly embedded ones, requires the understanding that the entire device is a kind of extension of the antenna.

It is therefore helpful to have a basic understanding of the key antenna parameters and to be aware of the differences and pitfalls in interpretation. The following standard electrical antenna parameters, for example, are listed on data sheets:

- Frequency, frequency range
- Polarization
- Impedance
- VSWR, maximum VSWR
- Return loss, maximum return loss
- Radiation efficiency, average efficiency, total efficiency
- Peak gain, average gain, maximal gain, minimum gain
- Radiation pattern plots

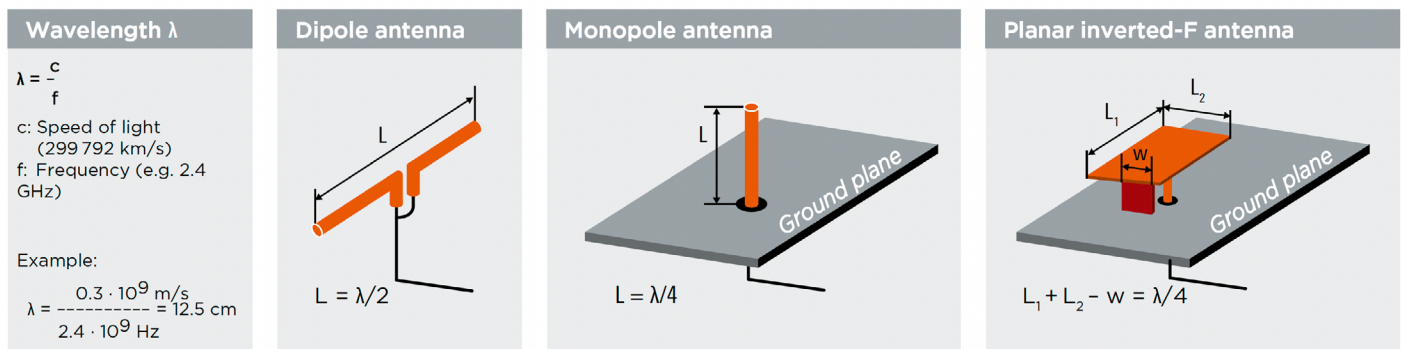

Figure 2-2: Wavelength/dimensions of different types of antennas

All the listed electrical parameters and plots are typically measured on a reference platform in free space or with a reference ground plane as specified in the data sheet. Moreover, incorrect implementation can cause RF-related metrics to fluctuate. For those new to antenna design, consulting competent experts and using pre-certified antenna solutions is recommended.

2.1 ANTENNA PRINCIPLES

In short, the antenna converts radiated electromagnetic waves into conducted voltage/current waves or vice versa by having the same properties (reciprocity), e.g. an identical antenna pattern in transmit and receive mode.

Figure 2-1 shows how radiated electromagnetic waves cause electrons to move in the receiving antenna, thereby creating an electrical signal.

For optimum efficiency, the antenna needs to resonate at the operating frequency (f). This is essentially the case when the length of the radiating parts of the antenna element is an integral multiple/fraction of the wavelength ($\lambda = c/f$). The optimal dimensions of an antenna depend on the antenna type. For example, a dipole antenna resonates best when its length is half of the wavelength. For monopole antennas, you would typically use a quarter wavelength due to the effect of the ground plane.

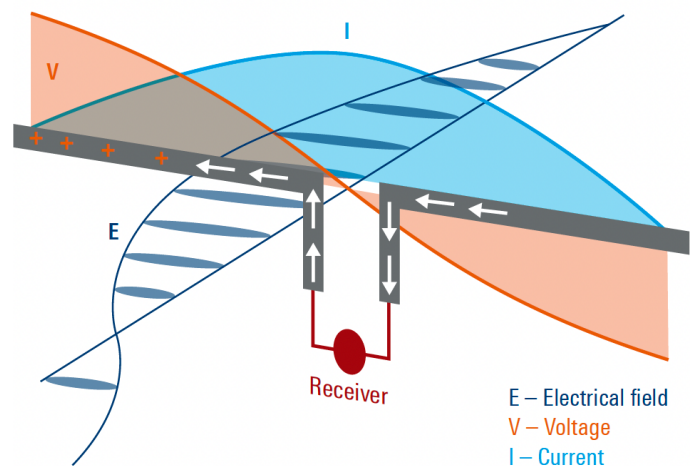

Figure 2-1: Principle of a receiving antenna

2. ANTENNA SELECTION BASED ON DATA SHEETS

2.2 ANTENNA MATCHING

A good total efficiency of a transmitting antenna system can only be achieved when the power (P_{FOR}) is forwarded almost entirely from the transmitter to the antenna (accepted power: P_{ACC}). This requires impedance matching between the RF system and antenna. A poorly matched antenna system will reflect valuable energy back to the transmitter, which may heat up the entire transmission network and potentially damage the transmitter.

A common measure of how well the antenna impedance matches the transmission line is known as the voltage standing wave ratio (VSWR), which defines the level of standing waves on the transmission line. In reality, there will always be a mismatch between the transmission network and the antenna, causing a certain percentage of power to be reflected (P_{REF}) from the antenna to the source. The forward and reflected waves will interfere with each other on the transmission line, which creates a voltage standing wave that can be numerically evaluated by the parameter VSWR.

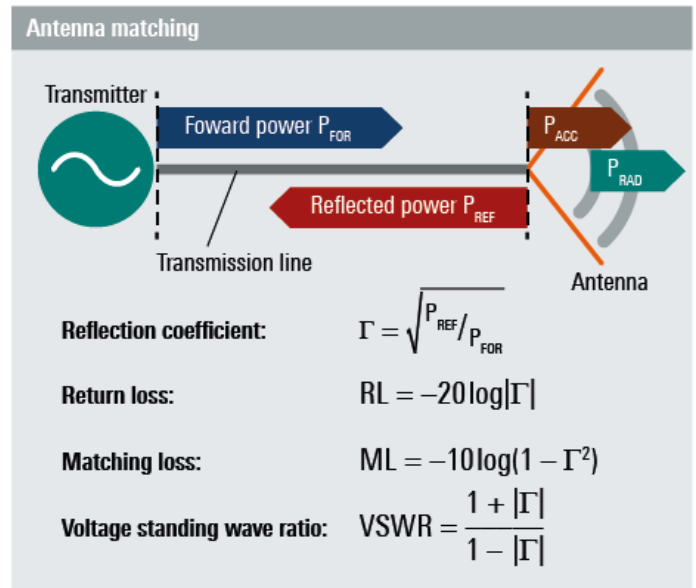

Figure 2-3: Antenna matching parameters

TABLE 2-1: CONVERSION TABLE BETWEEN VSWR, RL AND ML

VSWR (:1)	Return loss (RL)	Mismatch loss (ML)	Accepted power ratio
1.0	∞	0.0 dB	100 %
2.0	9.5 dB	0.5 dB	89 %
3.0	6.0 dB	1.2 dB	75 %
4.0	4.4 dB	1.9 dB	64 %
5.0	3.5 dB	2.6 dB	56 %
6.0	2.9 dB	3.1 dB	49 %
7.0	2.5 dB	3.6 dB	44 %

The VSWR is a real number that is always greater than or equal to 1. A VSWR of 1 indicates that the antenna is perfectly matched to the transmission line (no mismatch loss). Higher VSWR values indicate worse performance.

As an example of common VSWR values, a VSWR of 3.0 indicates that about 75% of the power is accepted by the antenna (1.2 dB of mismatch loss). Besides the VSWR value, the return loss (RL) and the mismatch loss (ML) are also used to express the quality of antenna matching.

Table 2-1 shows the conversion between these parameters.

The VSWR and RL are fundamental parameters in evaluating antenna performance. These parameters therefore need to be considered carefully during antenna design.

In general, a VSWR of 6 or more (return loss of less than 3 dB) is high and needs to be improved. A VSWR of less than 2 or a return loss of more than 10 dB is often regarded as good antenna matching.

The VSWR or RL chart that is normally available on every data sheet represents the magnitude of the reflection factor as a function of frequency. For optimization purposes, it is also worth observing the antenna's impedance, which is usually represented on the smith chart and helps engineers visualize the resistance and reactance vectorial components by plotting a point for each frequency on a curve in the complex space (see section 5.1).

Watch the Rohde and Schwarz video on YouTube

Understanding VSWR and Return Loss
www.youtube.com/watch?v=BijMGKbTOWk

2. ANTENNA SELECTION BASED ON DATA SHEETS

2.2 ANTENNA MATCHING

The VSWR is also used to define additional parameters such as the impedance bandwidth, which describes the range of frequencies over which the antenna can properly radiate or receive energy.

The impedance bandwidth is typically quoted in terms of VSWR. For example, the left chart in **Figure 2-4** shows a **broadband antenna operating** in the frequency range from 1 GHz to 9 GHz with a $VSWR \leq 2$.

The antenna impedance bandwidth can be expressed as an impedance bandwidth ratio (typically used for broadband antennas) or as a fractional bandwidth (FBW) or percentage bandwidth for narrowband antennas, as shown in the right chart in Figure 2-4.

2.3 ANTENNA EFFICIENCY

The radiation efficiency of an antenna is defined as the ratio between the power accepted by the antenna (P_{ACC}) and the power radiated from the antenna (P_{RAD}). A highly efficient antenna will radiate most of the power. An inefficient antenna will lose energy because of losses within the antenna.

The antenna efficiency can be described in terms of loss as radiation resistance (R_R) caused by the radiation of electromagnetic waves from the antenna, and loss resistance (R_L) caused by conduction and dielectric loss. The terms “total efficiency” and “total antenna efficiency” are sometimes used too. This describes the ratio between the power forwarded to the antenna (P_{FOR}) and the radiated power (P_{RAD}) and therefore covers the antenna matching and the radiation efficiency aspects.

As explained in section 2.2, the antenna matching can be verified and optimized based on VSWR measurements. The antenna efficiency gives a broader view and is one of the fundamental antenna parameters.

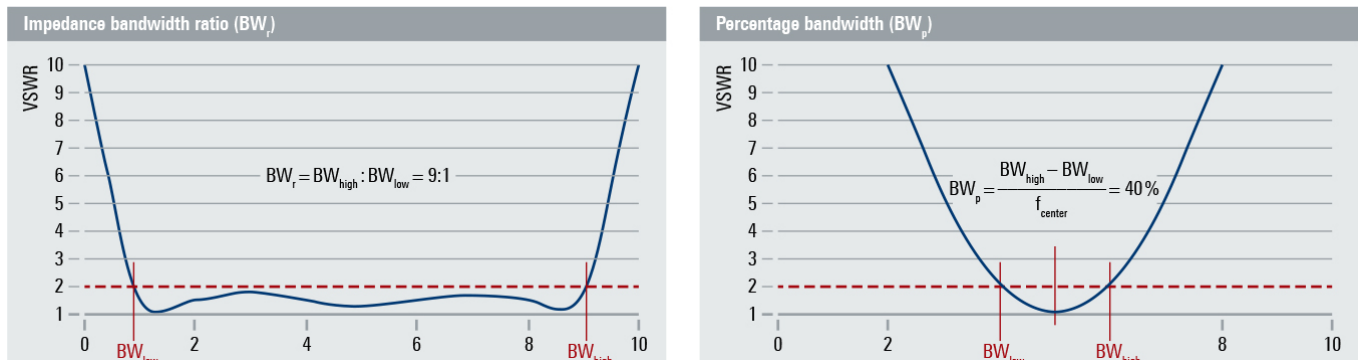

Figure 2-4: Bandwidth parameters defined by VSWR (≤ 2)

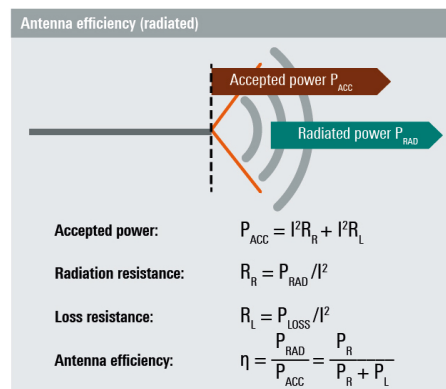

Figure 2-5: Antenna radiation efficiency

Antenna efficiency and bandwidth are closely tied to the dimensions of the antenna. One of the objectives of the antenna supplier is to provide high efficiency and appropriate bandwidth with an optimal antenna size to meet the needs of the users.

2. ANTENNA SELECTION BASED ON DATA SHEETS

2.4 ANTENNA POLARIZATION AND RADIATION

Antenna polarization, which is influenced by the direction of the electric field component, is an important characteristic for the design of antennas and the integration of antennas into wireless devices. Each antenna has its own characteristic polarization, and the problem of matching the polarization directions of the transmitting and receiving antennas is an important issue.

For example, the polarization of the received electromagnetic waves must match the polarization of the receiving antenna to work effectively. This ensures that the maximum amount of energy is converted from radiated waves into an electrical signal. If the received antenna polarization does not match that of the incoming signal, the signal level will decrease accordingly.

Figure 2-6 shows typical polarization types including linear. Linear polarization can essentially be classified as vertical or horizontal linear. Circular polarization can be classified as right-handed or left-handed.

The antenna pattern or radiation pattern are representations of the directional distribution of radiated energy into space. The antenna pattern plotted in two or three-dimensional graphs is usually measured under far field conditions with dedicated test setups see section 5.2. For example, the 3D antenna pattern of an ideal isotropic antenna would look like a sphere because the energy is radiated equally in all directions.

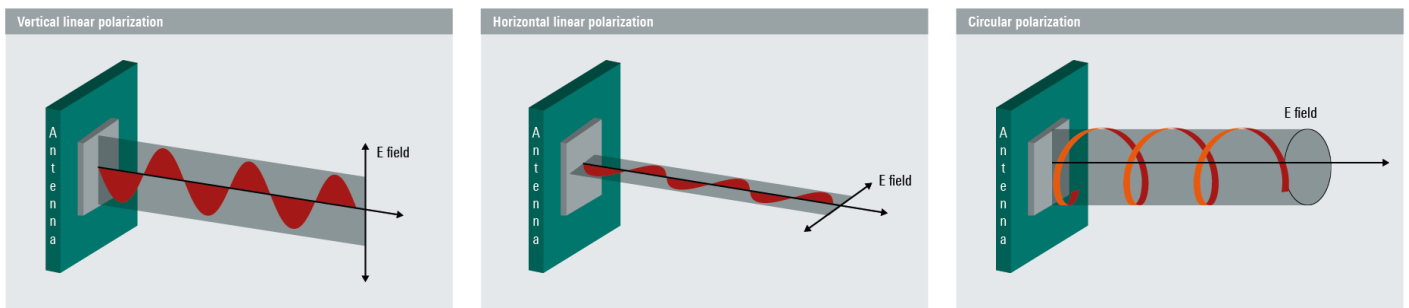

Figure 2-6: Various antenna polarization schemes

The 3D pattern of an omnidirectional dipole antenna would look more like a donut, as shown in Figure 2-7. The 2D radiation patterns usually depict a certain cross-section of the 3D radiation pattern, allowing the user to better understand the footprint of the antenna in its surrounding space.

Figure 2-8 shows 2D and 3D graphs of typical radiation from a directional patch antenna.

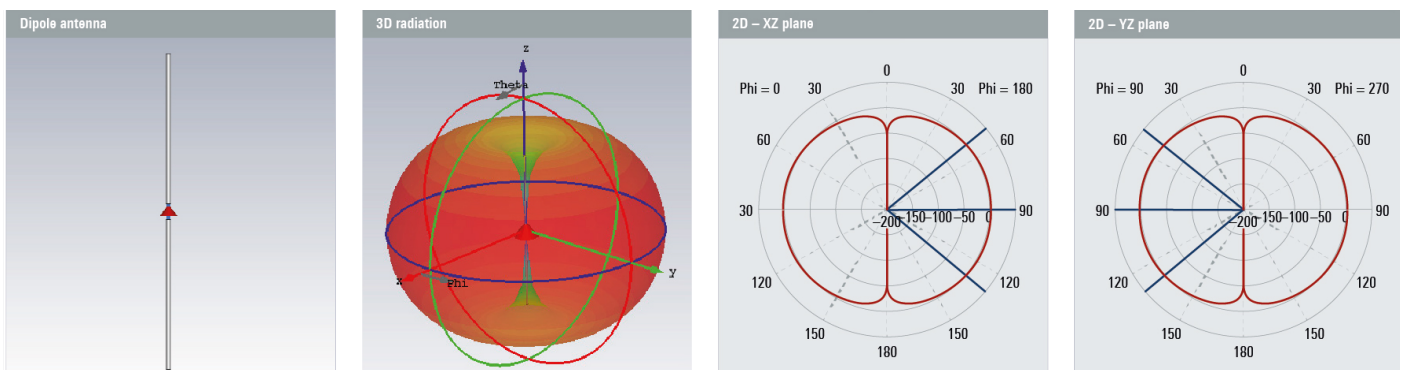

Figure 2-7: Radiation patterns of dipole (omnidirectional) antenna in 3D and 2D

2. ANTENNA SELECTION BASED ON DATA SHEETS

2.4 ANTENNA POLARIZATION AND RADIATION

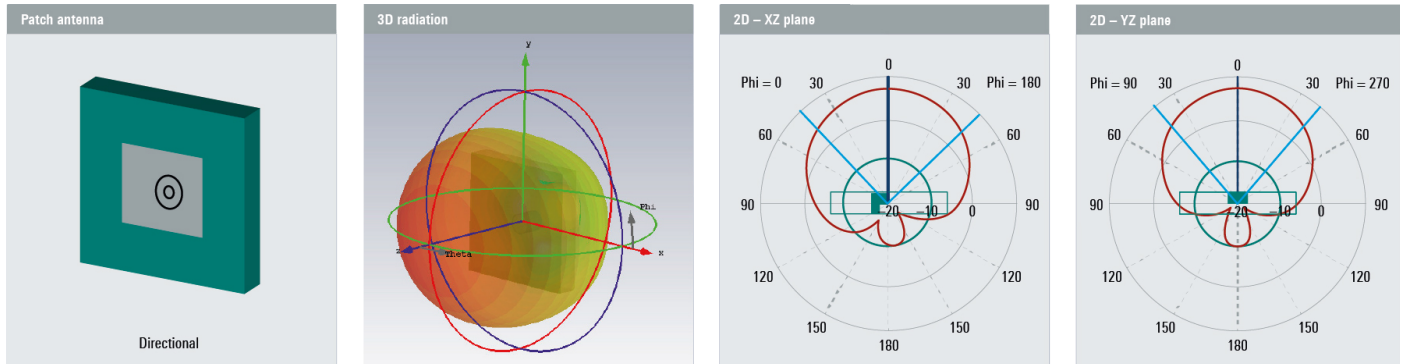

Figure 2-8: Radiation patterns of a directional patch antenna in 3D and 2D

2.5 ANTENNA GAIN

Antenna gain is a key parameter of an antenna that reflects its directivity. In a transmitting antenna, the gain describes how much power is radiated in the direction of peak radiation compared to that of an isotropic source, which would radiate the same intensity of radiation in all directions.

In a receiving antenna, the antenna gain represents how well the antenna converts radio waves received from a specified direction into electrical power.

The antenna gain is defined in relation to a reference antenna. The isotropic radiator is usually used as a reference antenna, and the gain value then given in dBi. For some applications, the halfwave dipole is used as a reference, indicated by the unit dBd. To convert from dBd to dBi, add 2.15 dB.

It is worth mentioning that an antenna with high antenna gain is not always the best choice primarily because high antenna gain means high directivity or a very narrow antenna beam. Applications requiring radio transmission in all directions need low directivity, or moderate antenna gain.

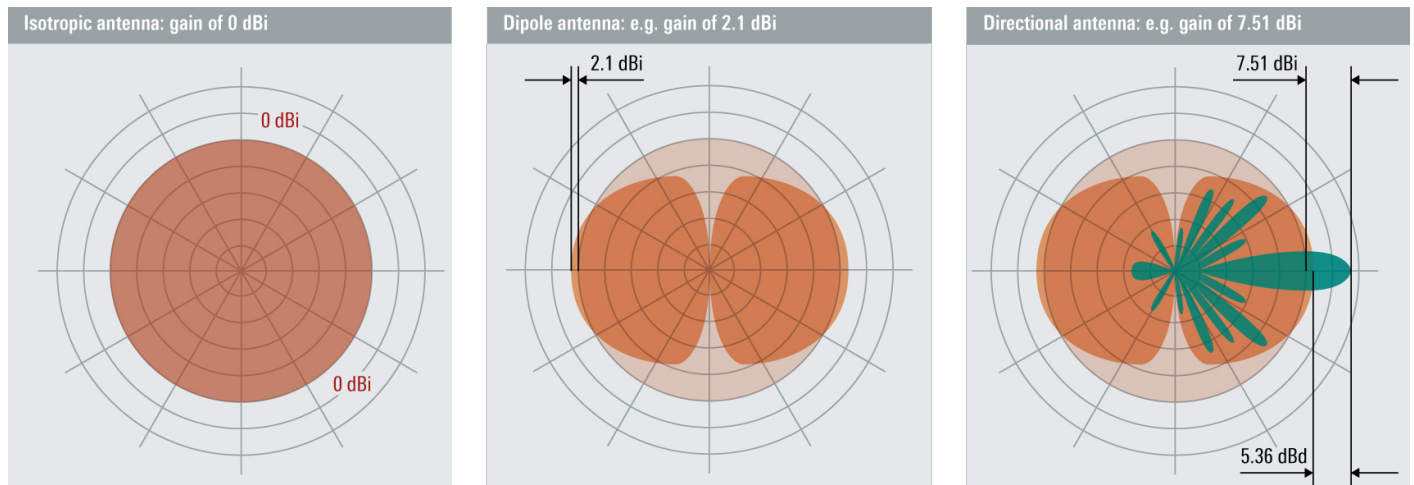

Figure 2-9: Antenna gain dependent on directivity shown in 2D antenna patterns

3. FACTORS AFFECTING EMBEDDED ANTENNA PERFORMANCE

There are several factors that can affect the overall antenna performance, including:

- Shape and dimension of the ground plane
- Nearby components
- Outer casing and its material
- Antenna position within the device
- Layout of the PCB (power/noise issues)

3.1 GROUND PLANE DIMENSIONS

Unlike dipole antennas, all monopole antennas are dependent on the ground plane, which acts as the other half of the antenna (image antenna). Consequently, the size of the ground plane and its proximity to the antenna affect efficiency and operational frequency. For example, $\lambda/4$ monopole antennas require a ground plane with a length of at least $\lambda/4$. In general, antennas perform better with a larger ground plane.

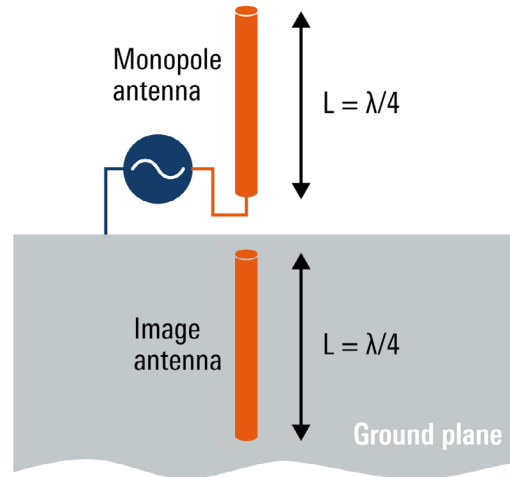

Figure 3-1: Antenna on ground plane

Figure 3-2 shows the VSWR comparison data of a cellular SMD antenna dependent on the length of the ground plane at different frequencies. In the frequency range from 0.5 GHz to 1 GHz (wavelength: 600 mm to 300 mm), the VSWR becomes quite high. For the variant with a ground plate length of 120 mm, the VSWR reaches a value of 4.0 compared to a value of less than 3.0 for the other variants.

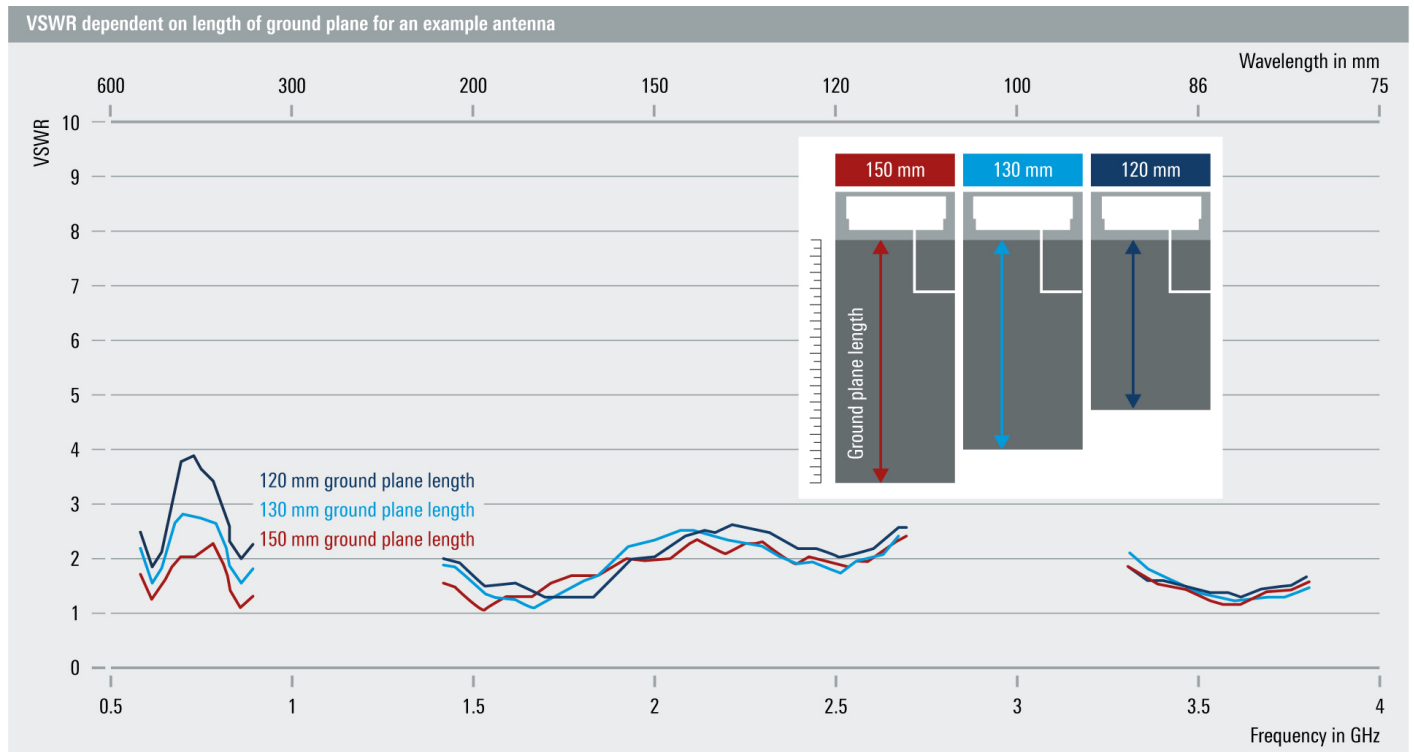

Figure 3-2: VSWR dependent on length of ground plane

3. FACTORS AFFECTING EMBEDDED ANTENNA PERFORMANCE

3.2 OTHER NEARBY COMPONENTS

Material surrounding the antenna can seriously affect its performance. It is therefore recommended to avoid placing any metallic or conductive components in close proximity to the antenna. The minimum distance or the size of the antenna exclusion zone depends on the antenna type.

Antenna performance is greatly affected by the components adjacent to the antenna. For example, bringing metal components close to the antenna will change the radiation pattern by increasing the directivity and influencing the value and direction of the peak gain.

Another example is two antennas placed closely together on a printed circuit board: a dual Wi-Fi (MIMO) stamped antenna and a Bluetooth slot antenna both operating in the 2.4 GHz ISM band as shown in Figure 3-3. Here, the additional effect of mutual coupling between antennas applies. The energy that should be radiated away from one antenna is absorbed by a nearby antenna.

The left graph shows a setup with sufficient distance between the antennas. The return loss is well matched to the operating frequency and the isolation of less than -15 dB is sufficient.

In the right graph, the Bluetooth slot antenna is placed closer to the Wi-Fi antenna, which affects the antenna performance: the return loss curve is shifted down from the operating frequency and the isolation in the ISM band stays between only -10 dB and -15 dB.

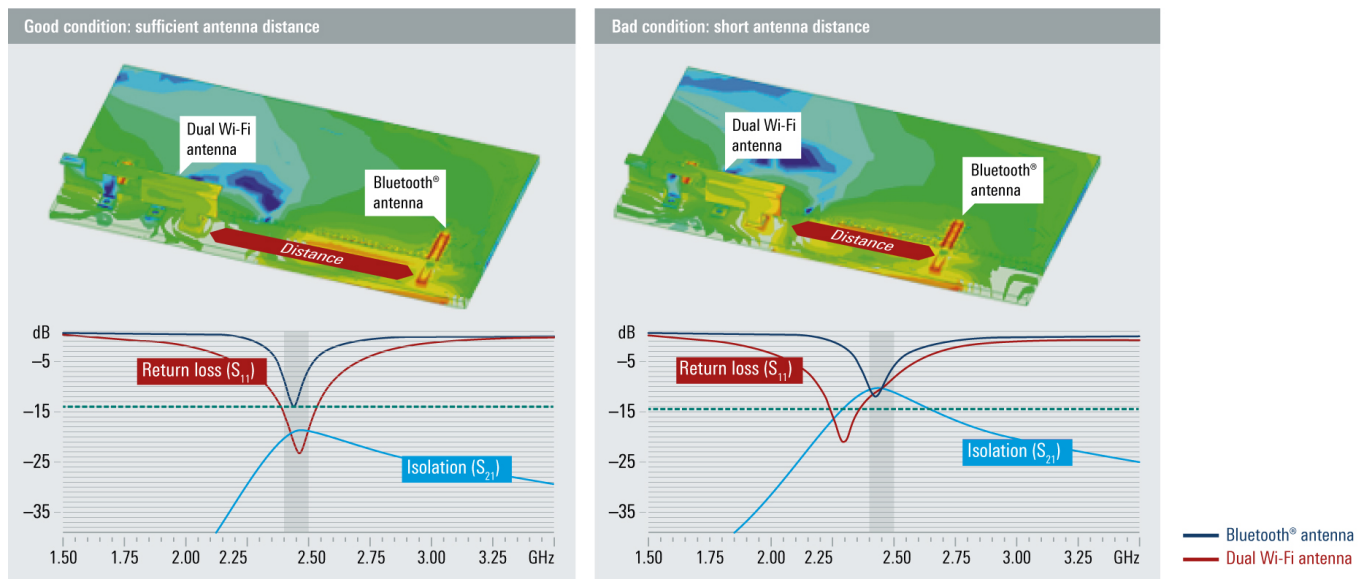

Figure 3-3: Example of impaired antenna function caused by a close slot antenna

3. FACTORS AFFECTING EMBEDDED ANTENNA PERFORMANCE

3.3 ENCLOSURE PROXIMITY AND MATERIAL EFFECTS

Since components in close proximity to the antenna have an impact on performance, it is not surprising that the housing material will also have an impact. First of all, antennas should not be placed in a metallic cover. If the product has a metallic casing or a shield, it should not cover the antenna. Other types of housing material also affect the antenna parameters. For example, if an antenna is placed near plastic housing, the resonance frequency will shift lower than without casing because of the permittivity of plastic (see Figure 3-4).

All measurements and alignments on the antenna(s) should therefore always be performed with the complete enclosure or housing in place.

3.4 POSITION WITHIN THE DEVICE

The location of the antenna in the device is another key consideration for optimizing performance. Antennas are typically placed at the corner or center edge of the circuit board with clearance from the rest of the circuit. Check the vendor's design recommendations regarding the exclusion zones as well as guidelines for the ground plane. In cases where the specific recommendations cannot be implemented, consult RF experts for a holistic view and to adjust the antenna or design a specific antenna to optimize performance for a given device design.

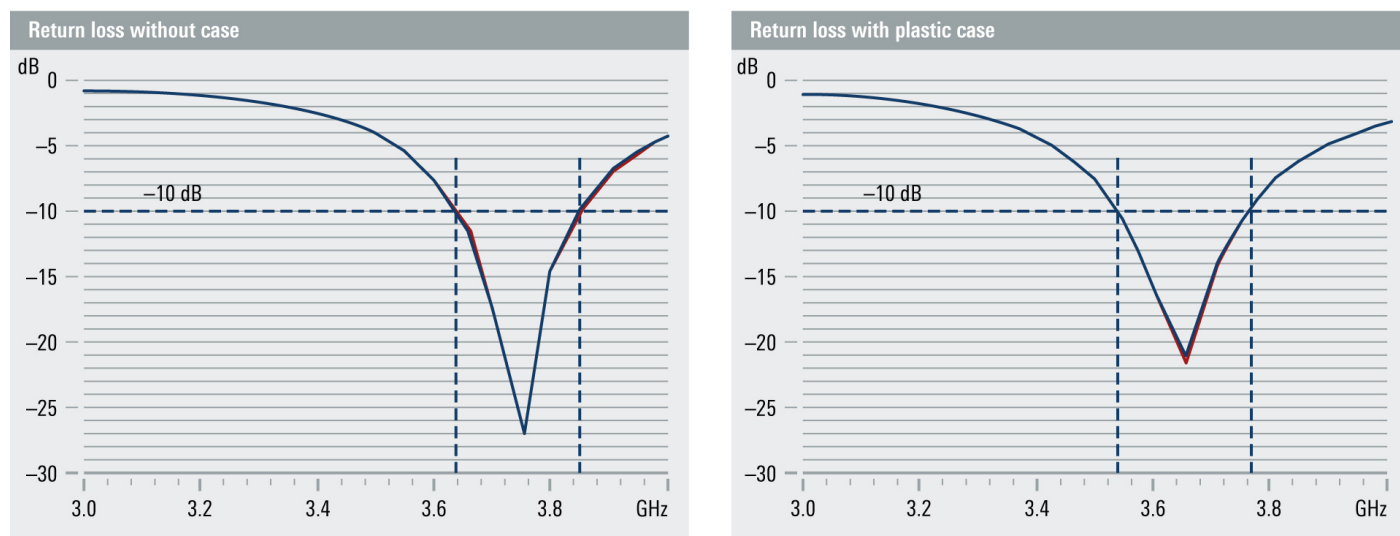
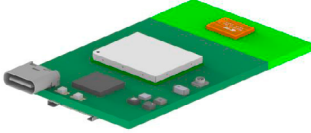
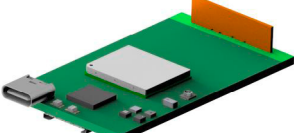
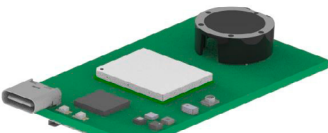

Figure 3-4: Return loss measured with and without plastic case

3. FACTORS AFFECTING EMBEDDED ANTENNA PERFORMANCE

VARIOUS OPTIONS FOR ANTENNA IMPLEMENTATION

BOARD-MOUNTED ANTENNAS

Surface mount	Tab mount	Surface mount on ground
 <ul style="list-style-type: none"> • Smaller size, low profile • Ideal for very thin devices 	 <ul style="list-style-type: none"> • Higher profile of 10 mm to 20 mm • Can save PCB space and helps with good antenna performance 	 <ul style="list-style-type: none"> • Higher profile of 5 mm to 25 mm • On-ground type ideal for single/dual high-band antennas

EMBEDDED ANTENNAS

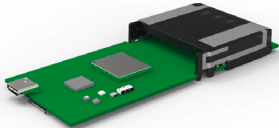
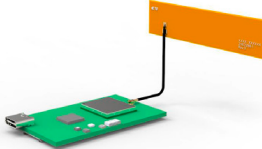
Chassis mount with direct feed	Chassis mount with cable feed
 <ul style="list-style-type: none"> • Compact antenna using existing ground plane • Automatic and repeatable assembly 	 <ul style="list-style-type: none"> • Large antenna with ground plane independent of antenna • Requires manual assembly

EXTERNAL AND TERMINAL ANTENNAS

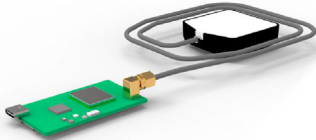
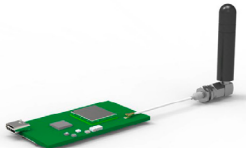
External	Terminal mount
 <ul style="list-style-type: none"> • Little or no dependency on device ground • Minimal RF design effort - ready-to-use 	 <ul style="list-style-type: none"> • Dependency on device ground increases at lower frequencies • Easy manipulation with minimal RF design effort

3. FACTORS AFFECTING EMBEDDED ANTENNA PERFORMANCE

3.5 LAYOUT OF THE PCB

The ground structures in the PCB are another critical element for optimizing antenna performance. Performance benefits from a continuous planar ground. It is therefore recommended to avoid splitting the ground into multiple sections by routing traces through the antenna grounding structure.

The top and bottom layers have ground structures that need to be properly connected by via holes. Ideally, the intermediate layers should also have ground planes connected to the PCB grounding system. It is important to avoid floating grounds (not connected) in the design.

Routing all signal and power lines between grounding structures and flooding all unused PCB surfaces with ground is recommended.

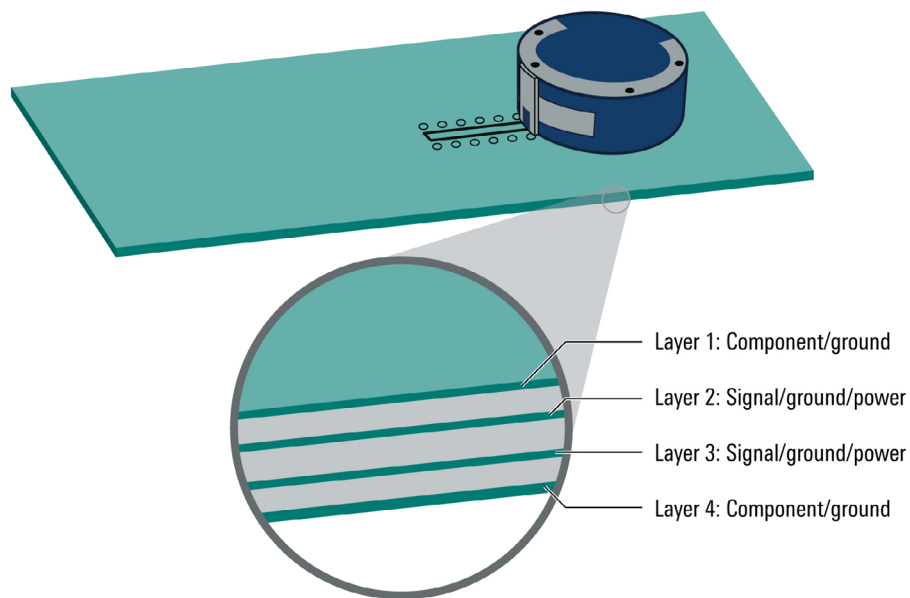

Figure 3-5: Example of RF PCB layout for proper grounding, with TE puck antenna

4. NEXT GENERATION MULTI-BAND ANTENNAS

Cellular IoT devices designed for global operation would particularly benefit from antennas that work efficiently in all required operating bands.

A new concept using metamaterial technology covers virtually all cellular bands (< 7 GHz) in one compact antenna assembly. MetaSpan antennas are developed using TE's metamaterial antenna technology. This type of antenna differs greatly from standard antenna designs. It uses the capacitive coupling and inductive loading of the antenna structure to generate a "left-hand" mode.

The graph below illustrates how MetaSpan antenna lefthand (LH) elements are combined with traditional right-hand (RH) elements to increase bandwidth. TE's MetaSpan antenna is intrinsically designed with capacitive coupling and inductive loading. The generated left-hand mode is the key differentiator compared to standard antenna structures. Its benefits include:

Enhancing low-band bandwidth and efficiency

- Reducing antenna size
- Intrinsic matching
- Better stability compared to body loading
- Confining currents on or near the structure to help prevent coupling with adjacent RF components or other antennas

TE has developed one of the world's smallest 5G NR FR1 tab mount PCB antennas with wide impedance bandwidth. The antenna is 60 mm long, 20 mm wide and 1.6 mm thick. It can cover low band from 698 MHz to 960 MHz and high band from 1420 MHz to 7125 MHz with high efficiency and good return loss, as can be seen in Figure 4-2 and Figure 4-3. This range of frequencies covers all 5G NR FR1 frequency bands except band n71.

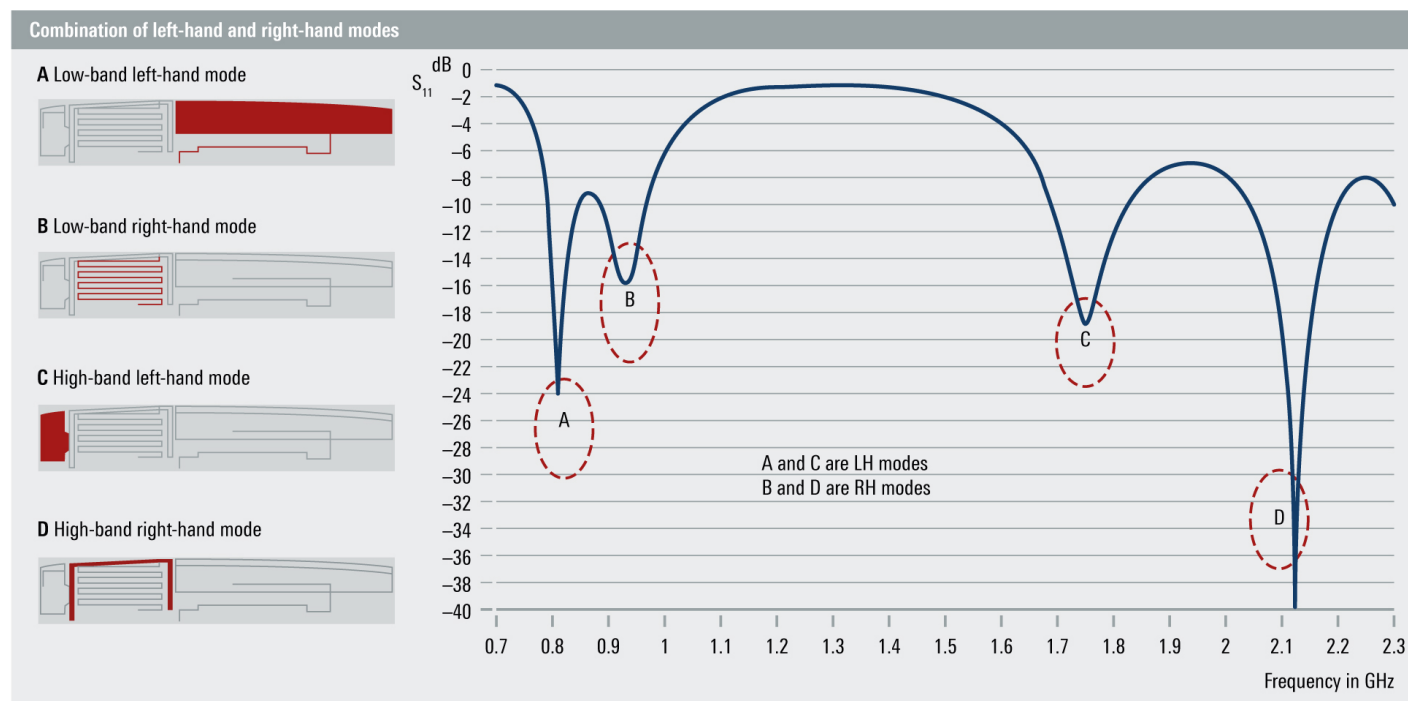

Figure 4-1: Combination of LH and RH modes on a MetaSpan antenna

4. NEXT GENERATION MULTI-BAND ANTENNAS

VSWR plot of a 5G NR antenna covering almost all FR1 bands with a VSWR ≤ 3

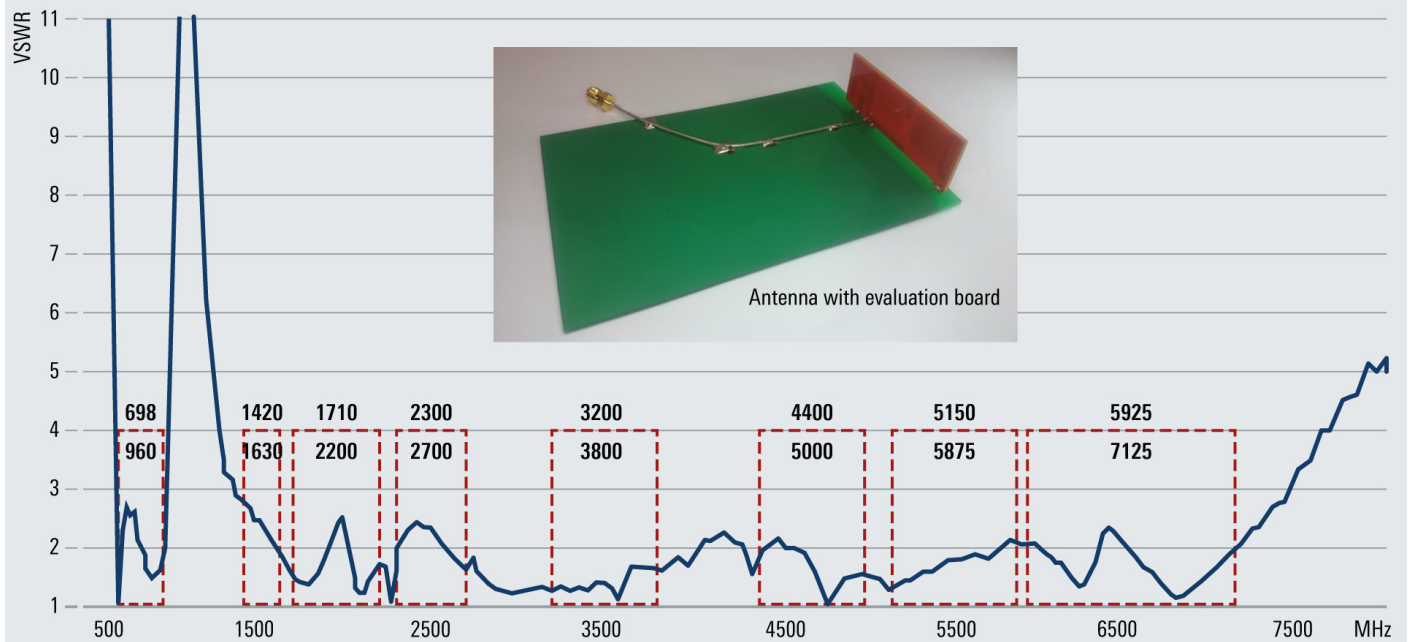

Figure 4-2: VSWR plot of a 5G NR FR1 MetaSpan antenna

Antenna efficiency of a 5G NR antenna covering almost all FR1 bands with an efficiency of $\geq 50\%$

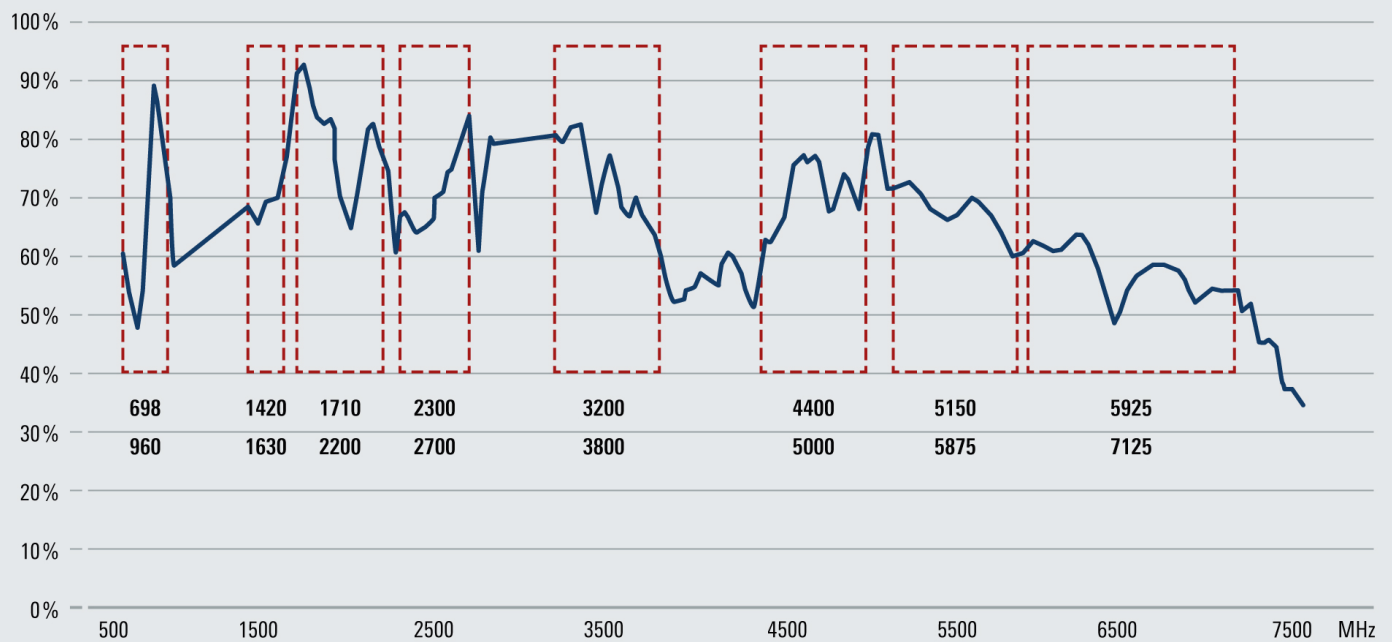

Figure 4-3: Efficiency plot of a 5G NR FR1 MetaSpan antenna

5. VALIDATING AND OPTIMIZING ANTENNA PERFORMANCE

Reviewing the data sheets, considering the guidelines for antenna integration and using simulation tools are good approaches for designing IoT devices that deliver best-in-class antenna performance.

Only the performance measurements on the integrated antenna's final design can prove whether the desired performance can be achieved.

Further tests and measurements can improve and speed up the development process. It might be beneficial to verify the data sheet parameters of the antenna by conducting in-house measurements or to analyze the impact of different ground planes, for example. Either way, optimization and tuning of the matching network definitely require conducted measurements for VSWR and return loss verification.

The only way to confirm that the final design achieves the expected antenna performance is over-the-air testing, which is also very often required or recommended for device certification.

TRUST IN THE POWER OF TESTING.



5. VALIDATING AND OPTIMIZING ANTENNA PERFORMANCE

5.1 BASIC ANTENNA MEASUREMENTS WITH A VECTOR NETWORK ANALYZER

The first step of antenna testing should be the verification of electrical parameters such as VSWR and return loss using a vector network analyzer (VNA). VSWR, return loss and impedance are based on the S-parameter S_{11} measurement performed using a one-port or two-port VNA such as the R&S®ZNL or the handheld R&S®ZNH.

The S_{11} measurement represents the complex coefficient between input voltage and reflected voltage, also known as the reflection coefficient. Thanks to the VNA's S-parameter wizard, it has never been easier to set up the measurements and to calibrate the test setup. Doing this in advance is highly recommended to achieve accurate measurement results.

Representing the complex S_{11} parameter as normalized impedance in a Smith chart is a very powerful tool for verifying and optimizing the antenna matching ($Z_L = Z_0$). The chart graphically displays the impedance of the resistive portion (resistance circles) and the reactive portion (reactance circles), with the top half being of inductive nature and the bottom half of capacitive nature. Each point on the chart identifies the impedance associated with a certain frequency.

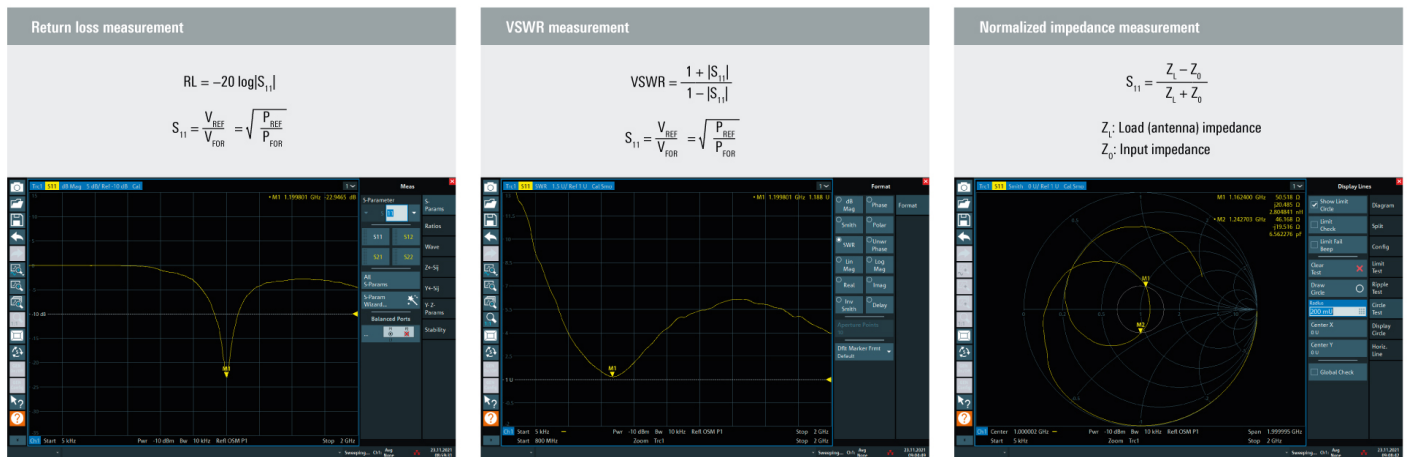

Figure 5-1: Different representations of the S_{11} parameter measured with the R&S®ZNL

5. VALIDATING AND OPTIMIZING ANTENNA PERFORMANCE

5.2 OVER-THE-AIR MEASUREMENTS

It is essential to perform over-the-air testing to check the overall RF performance of your IoT device. This requires special test setups with a device placed in an anechoic RF chamber with specific shielding characteristics, ideally equipped with a two-axis positioner to perform automated 3D measurements.

For accurate results, over-the-air measurements need to be performed under the far field condition criteria, determined by the maximum linear dimension of the antenna (D), also known as the radiating aperture size, and the wavelength (λ).

A direct far field measurement requires a sufficient distance to the measurement antenna, as shown in Figure 5-2. The minimum distance (R) is dependent on the maximum linear dimension of the antenna (D) and the wavelength (λ) of the operating frequency. For example, over-the-air measurements of a Bluetooth device operating at 2.4 GHz with a small antenna could be performed in the R&S®DST200 anechoic RF chamber.

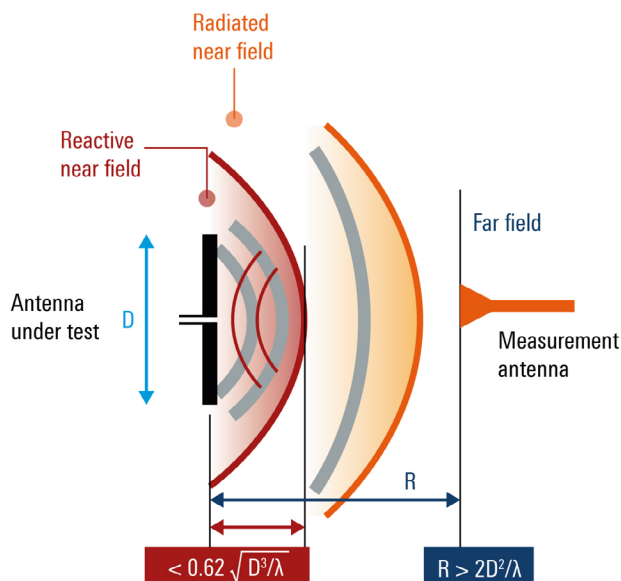

Figure 5-2: Far field condition criteria

Alternatively, a compact antenna test range (CATR) test system can create far field measurement conditions at a much shorter distance. For example, the R&S®ATS1800C can be used to measure 5G NR devices operating at mmWave frequencies (FR2).

Complete measurement of the 3D radiation pattern can be time-consuming due to the high number of measurement points.

Over-the-air measurements are essential to verify parameters such as gain, directivity, efficiency and to get an overview of the radiation characteristics. Moreover, over-the-air measurements are often required for the certification of certain devices, e.g. as defined by CTIA over-the-air test plans. These include the measurement of total radiated power (TRP) and total isotropic sensitivity (TIS), which are typically conducted by accredited test labs. Performing preformance measurements in advance is recommended to save time and helps reduce costs by avoiding multiple certification

Watch the Rohde & Schwarz videos on YouTube

Understanding S-Parameters

<https://www.youtube.com/watch?v=-PiOUbErHTY>

Understanding VNA Calibration Basics

<https://www.youtube.com/watch?v=bLfBg2p7PaE>

Understanding the Smith Chart

<https://www.youtube.com/watch?v=rUDMo7hwihs>

6. SUMMARY

This comprehensive IoT design guide provides essential information for engineers who design and validate antennas. It is applicable for today's and tomorrow's IoT applications and relevant for any kind of wireless IoT technology. Excellent antenna performance is essential for the overall success of an IoT application due to its high impact on key performance parameters such as coverage, power consumption and latency. Relying on experts in antenna design and integration and leveraging the power of testing in R&D, integration, certification and production is highly recommended.

7. LEARN MORE

VISIT OUR WEBSITE



REGISTER FOR OUR
NEWSLETTER



REGISTER FOR OUR
NEWSLETTER



8. ROHDE & SCHWARZ PRODUCTS FOR IoT ANTENNA TESTING

SPECTRUM AND VECTOR NETWORK ANALYZERS

R&S® ZNH full two-port handheld vector network analyzer

Offers one-port antenna measurement and full two-port S-parameter measurements.



R&S® FPC spectrum analyzer

Unexpected performance in entry class including one-port vector network analyzer functionality.

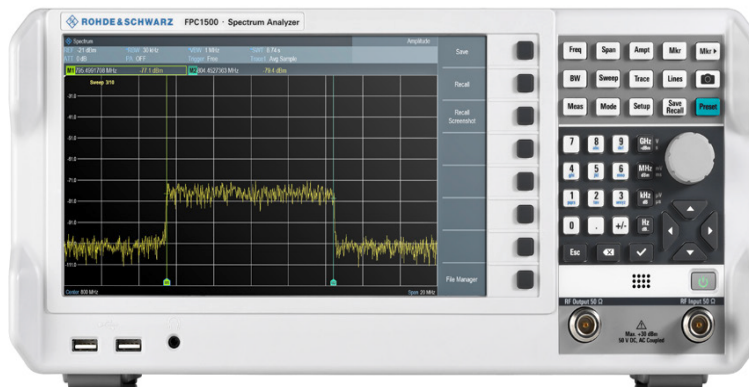

R&S® ZNLE vector network analyzer

The ideal choice for basic vector network analyzer applications.



8. ROHDE & SCHWARZ PRODUCTS FOR IoT ANTENNA TESTING

FULL ANECHOIC CHAMBERS

R&S®CMQ500 shielding cube

Optimized over-the-air test system for 5G FR1 and FR2 tests.

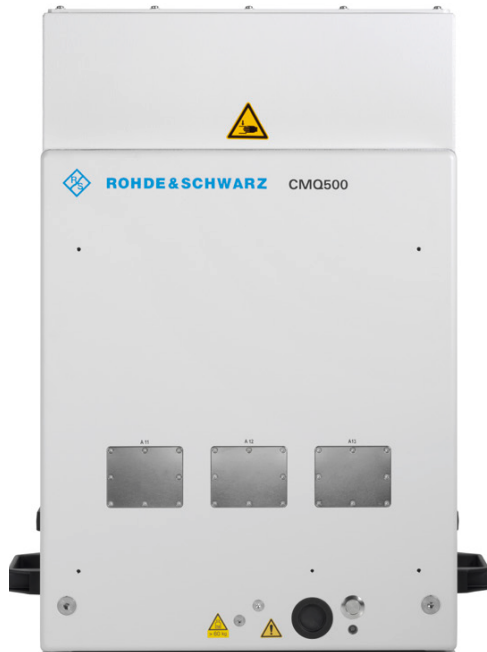

R&S®ATS1800C CATR based compact 5G NR mmWave test chamber

3GPP-compliant, transportable and compact CATR test chamber for 5G FR2



R&S®TS7124M RF shielded box

Enables reliable and reproducible measurements when a shielded test environment is needed.



R&S®DST200 RF diagnostic chamber

Ideal for development and supports a wide range of radiated test applications.



ABOUT ROHDE & SCHWARZ

The Rohde & Schwarz technology group is among the trailblazers when it comes to paving the way for a safer and connected world with its leading solutions in test and measurement, technology systems and networks and cybersecurity. Founded more than 85 years ago, the group is a reliable partner for industry and government customers around the globe. The independent company is headquartered in Munich, Germany and has an extensive sales and service network with locations in more than 70 countries.

www.rohde-schwarz.com

ROHDE & SCHWARZ CUSTOMER SUPPORT

www.rohde-schwarz.com



te.com

TE Connectivity, TE Connectivity (logo) and TE and MetaSpan are trademarks. All other logos, products and/or company names referred to herein might be trademarks of their respective owners.

The information given herein, including drawings, illustrations and schematics which are intended for illustration purposes only, is believed to be reliable. However, TE Connectivity makes no warranties as to its accuracy or completeness and disclaims any liability in connection with its use. TE Connectivity's obligations shall only be as set forth in TE Connectivity's Standard Terms and Conditions of Sale for this product and in no case will TE Connectivity be liable for any incidental, indirect or consequential damages arising out of the sale, resale, use or misuse of the product. Users of TE Connectivity products should make their own evaluation to determine the suitability of each such product for the specific application.

©2023 TE Connectivity. All Rights Reserved.

01/23 Original